

RADIANTE 1001 STANDARD INSTALLATION

LEGEND

- Firebox Dimension
 - ▲ Exact Dimension
 - Minimum Dimension
 - ➔ Air Intake
 - ⇨ Air Outlet
- Brick Masonry
OR
50mm Skamotec 225

NOTES:

- [1] Air intake grilles minimum air flow area required = 180cm² each side.
- [2] Air outlet grilles minimum air flow area = 240cm² each side and 480cm² if one grille is used.
- [3] Hearth height dimensions optional (Refer to Technical Data & Installation Instructions)
- [4] All dimensions in millimetres.
- [5] Heater can be left freestanding.
- [6] Do not scale from these diagrams
- [7] Air transfer kits mandatory for exempt units to comply to AS/NZ 4012/4013:2014. Fan optional depending on duct length. (Refer to Technical Data & Installation Instructions)

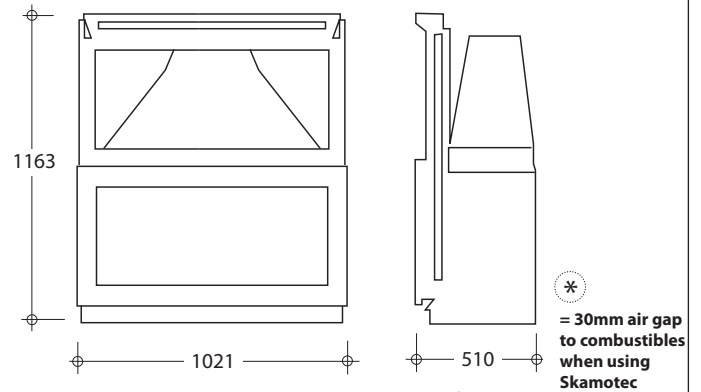

FIREPLACE CONSTRUCTION STEP 1

**IMPORTANT:
NO BRICKWORK TO
BE COMMENCED
UNTIL FIREBOX IS
PLACED IN POSITION**

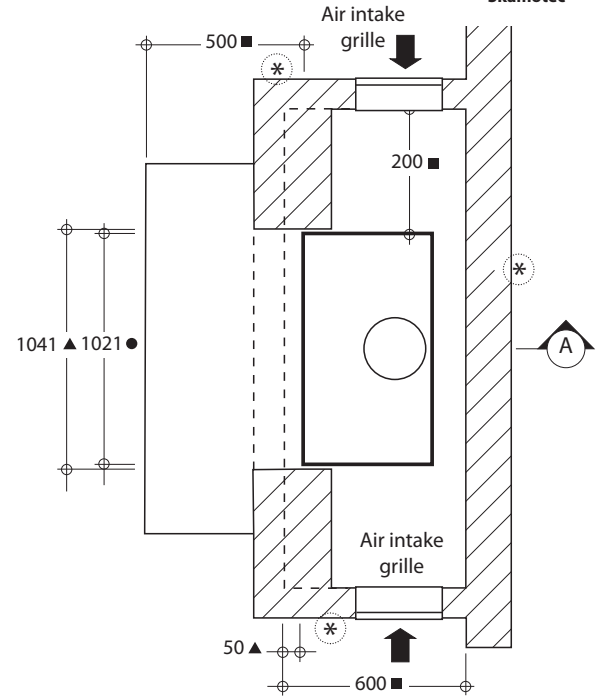
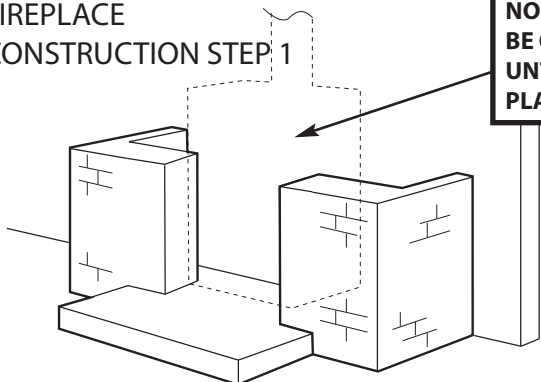

FIREPLACE CONSTRUCTION STEP 2

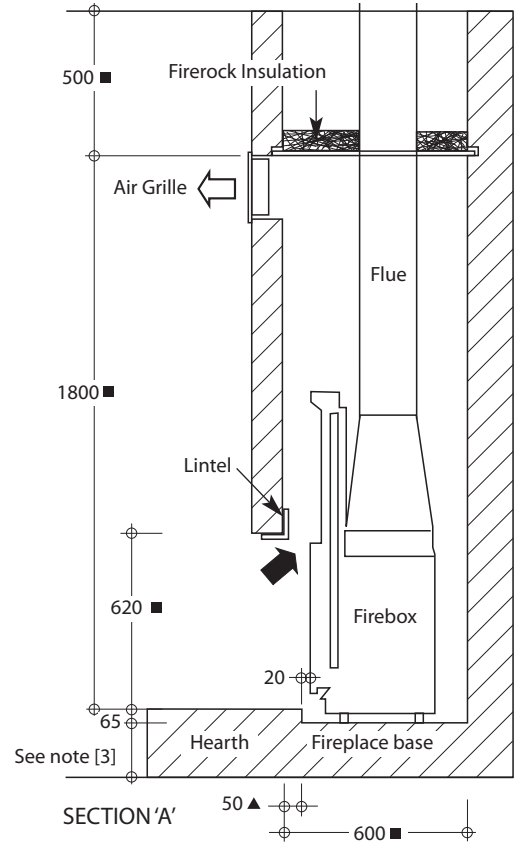
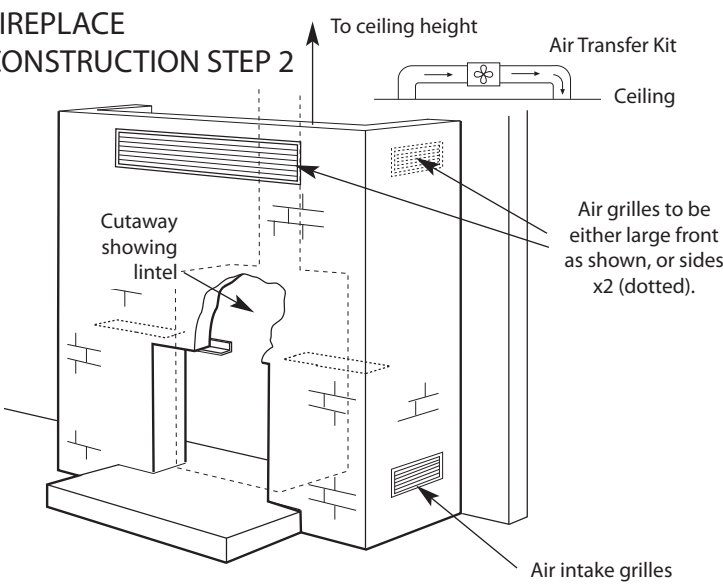

CHEMINEE PTY LTD

EMAIL sales@cheminee.com.au
 WEBSITE www.Cheminee.com.au
 PHONE 02 9564 2694
 FAX 02 9569 8802
 SHOWROOM
 118 Stanmore Road, Stanmore (Corner Wemyss St) NSW

**CHEMINÉES
PHILIPPE
A U S T R A L I A**