

# RADIANTE 1200DF STANDARD INSTALLATION

## LEGEND

- Firebox Dimension
  - ▲ Exact Dimension
  - Minimum Dimension
  - ➔ Air Intake
  - ⇨ Air Outlet
- Brick Masonry  
**OR**  
**50mm Skamotec 225**

## NOTES:

- [1] Air intake grilles minimum air flow area required = 180cm<sup>2</sup> each side.
- [2] Air outlet grilles minimum air flow area = 240cm<sup>2</sup> each side and 480cm<sup>2</sup> if one grille is used.
- [3] Hearth height dimensions optional (Refer to Technical Data & Installation Instructions)
- [4] All dimensions in millimetres.
- [5] Heater can be left freestanding.
- [6] Do not scale from these diagrams
- [7] Air transfer kits mandatory for exempt units to comply to AS/NZ 4012/4013:2014. Fan optional depending on duct length. ( Refer to Technical Data & Installation Instructions )

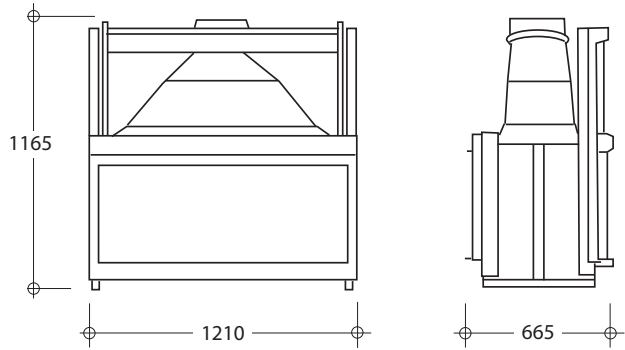

## FIREPLACE CONSTRUCTION STEP 1

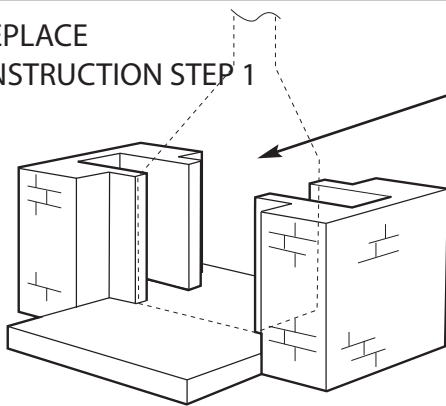

**IMPORTANT:  
NO BRICKWORK TO  
BE COMMENCED  
UNTIL FIREBOX IS  
PLACED IN POSITION**

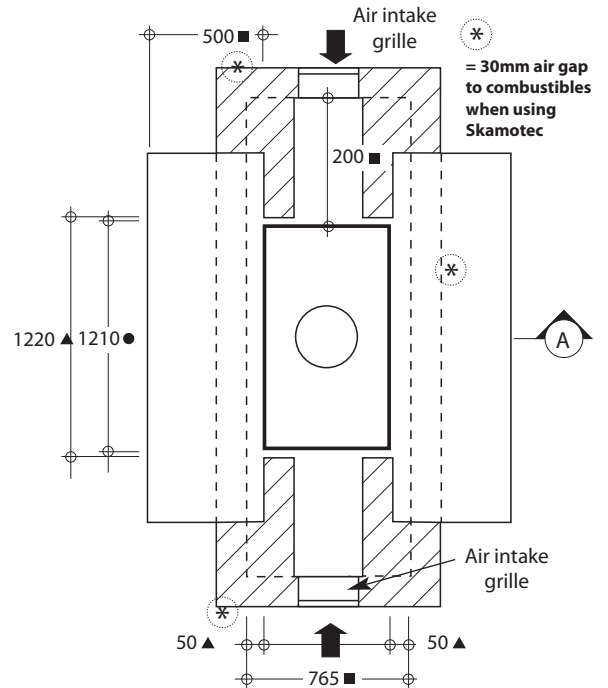

## FIREPLACE CONSTRUCTION STEP 2

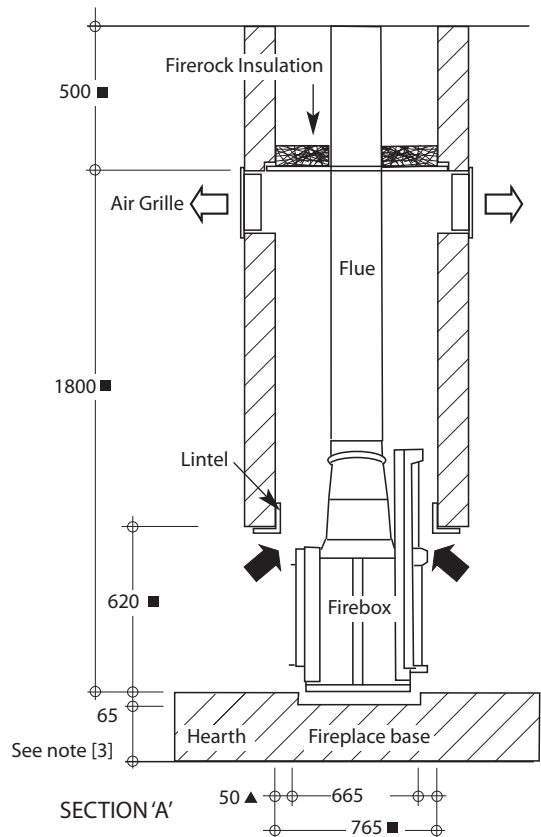
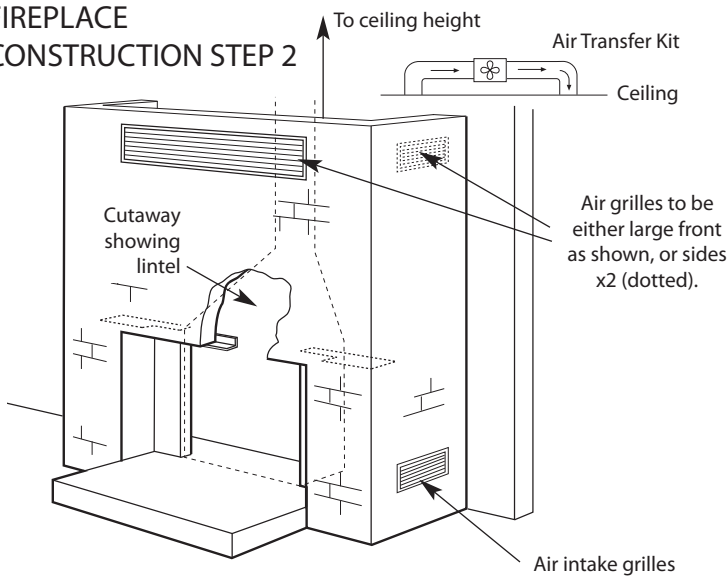

CHEMINEE PTY LTD

EMAIL [sales@cheminee.com.au](mailto:sales@cheminee.com.au)  
 WEBSITE [www.Cheminee.com.au](http://www.Cheminee.com.au)  
 PHONE 02 9564 2694  
 FAX 02 9569 8802  
 SHOWROOM  
 118 Stanmore Road, Stanmore (Corner Wemyss St) NSW

**CHEMINÉES  
PHILIPPE  
AUSTRALIA**